

Digital electronic drivers type E-RI-PES

integral-to-valve format, for variable displacement axial piston pumps with alternate P/Q control

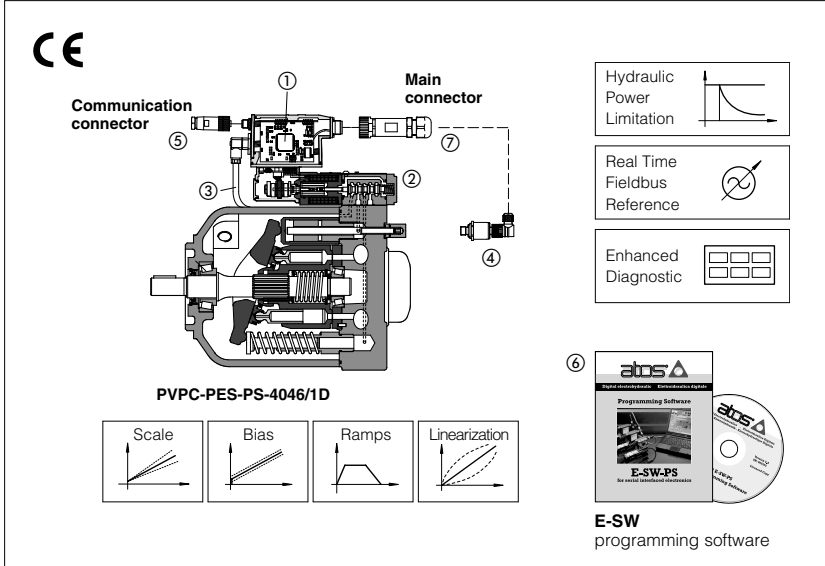

E-RI-PES digital drivers ① are integral to the servoproportional valve ② which pilot the variable displacement of axial piston pumps. They control, in closed loop, the flow and the pressure of the pump outlet line according to the two electronic reference input signals. The feedback of the integral swashplate transducer ③ is used to realize the flow closed loop.

The feedback of the integral or remote pressure transducer ④ is used for the pressure closed loop.

A dedicated and programmable algorithm selects which control will be active time by time:

- flow control is active when the actual system pressure is lower than the pressure reference input signal: the pump flow is regulated according to the flow reference input
- pressure control is activated when the actual pressure grows up to the pressure reference input signal: the pump flow is then reduced in order to regulate and limit the max system pressure (if the pressure tends to decrease under its command value, the flow control returns active)

Digital communication interface ⑤ allows to program the drivers with the Atos PC software ⑥.

Drivers executions with fieldbus communication interface (CANopen or PROFIBUS DP) are available to program and command the pumps directly by the machine control unit.

Electrical Features:

- Functional parameters are factory preset for best performances
- Standard 12 pin main connector ⑦ for power supply, analog input reference signals, monitor output and pressure feedback signals
- 5 pin connector ⑤ for communication interface, at choice: serial -PS or fieldbus (-BC or -BP)
- IP67 protection degree
- CE mark to EMC directive

Software Features:

- Setting of pump's functional parameters: bias, scale, ramps, dither
- Linearization function for both hydraulic regulations
- Setting of pump's dynamic response (PID) to optimize the application performances
- Hydraulic power limitation
- Range selection for the reference analog inputs: voltage or current (/I option)
- Complete diagnostics of driver status, solenoid and fault conditions
- Intuitive graphic interface

1 MODEL CODE

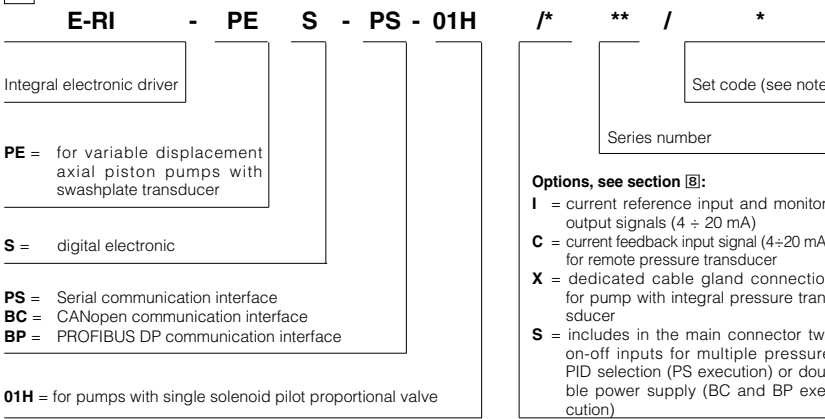

Note: the set code identifies the correspondance between the digital integral driver and the relevant valve; it is assigned by Atos when the driver is ordered as a spare part.

2 BLOCK DIAGRAM - Standard and Standard with /X option

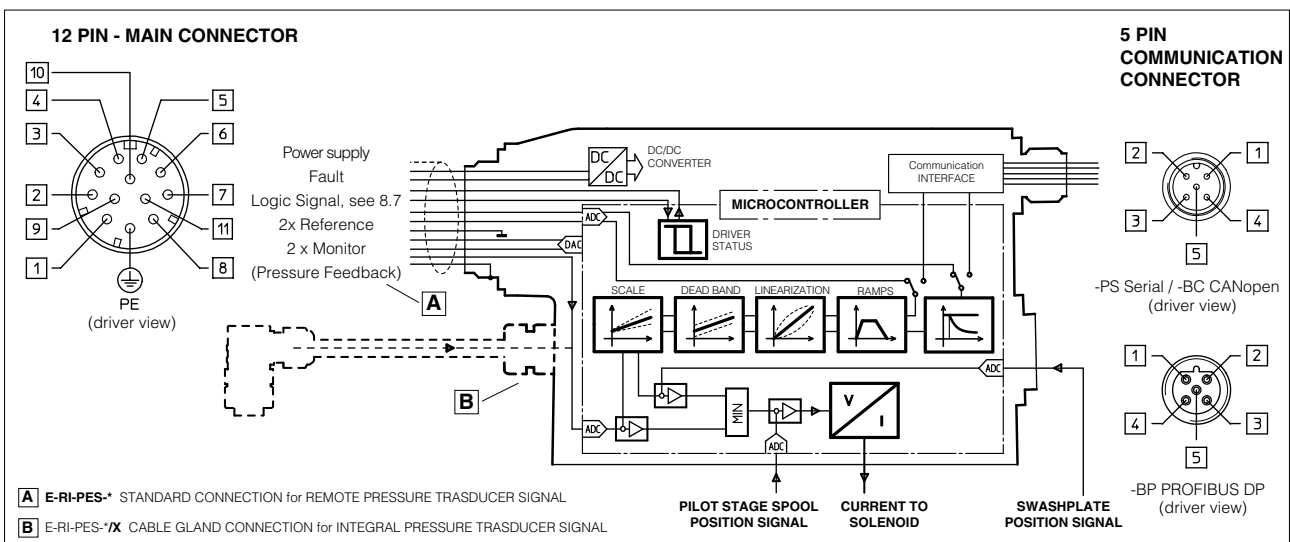

3 ELECTRONIC CONNECTIONS - Standard and Standard with /X option

PIN	SIGNAL	TECHNICAL SPECIFICATIONS	NOTES
1	V+	Power supply 24 Vdc for pilot valve's solenoid power stage - see 8.1	Input - power supply
2	V0	Power supply 0 Vdc for pilot valve's solenoid power stage - see 8.1	Gnd - power supply
3	FAULT	Driver status : Fault (0Vdc) or normal working (24 Vdc) - see 8.4	Output - on/off signal
4	AGND	Ground : signal zero for MONITOR signals (pin 6,8) and INPUT+ signals (pin 5,7)	Gnd - analog signal
5	Q_INPUT+	Flow reference: ± 10 Vdc maximum range (4 \div 20 mA for /I option) - see 8.2	Input - analog signal
6	Q_MONITOR	Flow monitor: ± 10 Vdc maximum range (4 \div 20 mA for /I option) - see 8.3	Output - analog signal
7	P_INPUT+	Pressure reference: ± 10 Vdc maximum range (4 \div 20 mA for /I option) - see 8.2	Input - analog signal
8	P_MONITOR	Pressure monitor: ± 10 Vdc maximum range (4 \div 20 mA for /I option) - see 8.3	Output - analog signal
9	D_IN	Power limitation enable, multiple pressure PID selection or driver enable (software selectable) - see 8.7	Input - on/off signal
10	TR (1)	Remote pressure transducer feedback: 0-10 Vdc maximum range (4 \div 20 mA for /C option) - see 8.5	Input - analog signal
11	AGND (1)	Ground : signal zero for TR signal (pin 10)	Gnd - analog signal
PE	EARTH	Internally connected to driver housing	

(1) : Do not connect for pumps with integral pressure transducer (standard with /X option).

Note: A minimum time of 270 to 590 ms have be considered between the driver energizing with the 24 Vdc power supply and when the pump is ready to operate; during this time the current to the valve coils is switched to zero.

These connections are the same of Rexroth A10VSO axial piston pumps, model SYDFEE and SYDFEC.

4 BLOCK DIAGRAM - /S and /SX option

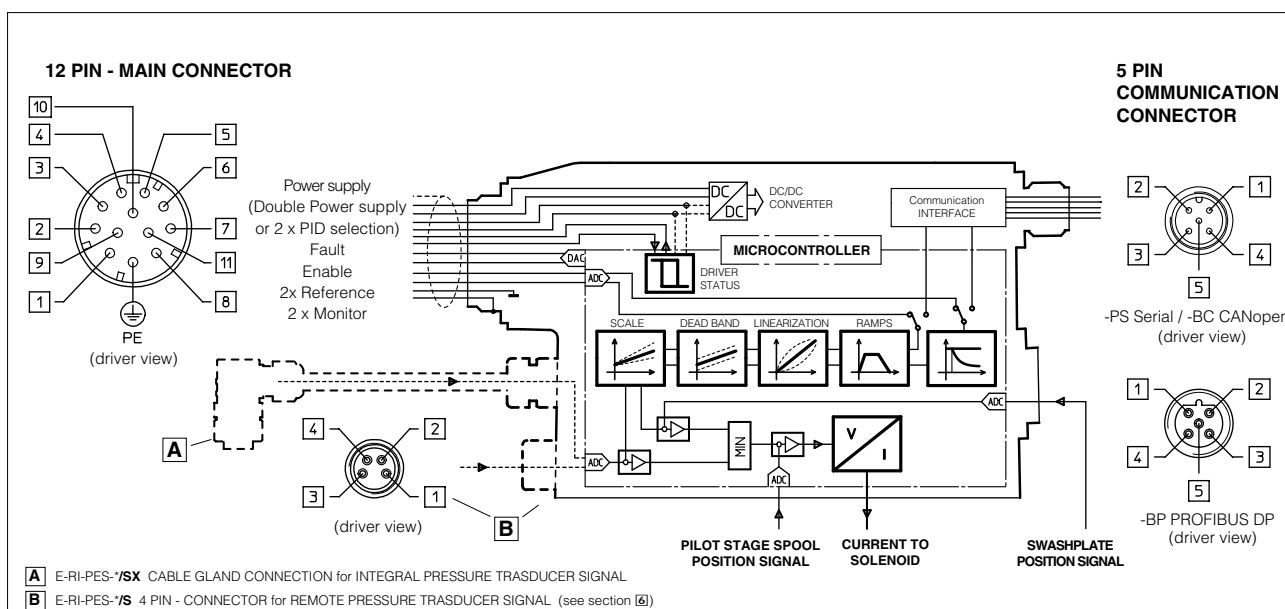

5 ELECTRONIC CONNECTIONS - /S and /SX option

PIN	SIGNAL	TECHNICAL SPECIFICATIONS	NOTES
1	V+	Power supply 24 Vdc for pilot valve's solenoid power stage - see 8.1	Input - power supply
2	V0	Power supply 0 Vdc for pilot valve's solenoid power stage - see 8.1	Gnd - power supply
3	ENABLE	Enable (24 Vdc) or disable (0 Vdc) the driver - see 8.6	Input - on/off signal
4	Q_INPUT+	Flow reference: ± 10 Vdc maximum range (4 \div 20 mA for /I option) - see 8.2	Input - analog signal
5	AGND	Ground : signal zero for MONITOR signals (pin 6,8) and INPUT+ signals (pin 5,7)	Gnd - analog signal
6	Q_MONITOR	Flow monitor: ± 10 Vdc maximum range (4 \div 20 mA for /I option) - see 8.3	Output - analog signal
7	P_INPUT+	Pressure reference: ± 10 Vdc maximum range (4 \div 20 mA for /I option) - see 8.2	Input - analog signal
8	P_MONITOR	Pressure monitor: ± 10 Vdc maximum range (4 \div 20 mA for /I option) - see 8.3	Output - analog signal
11	FAULT	Driver status : Fault (0Vdc) or normal working (24 Vdc) - see 8.4	Output - on/off signal
PE	EARTH	Internally connected to driver housing	
PS execution			
9	D_IN0	Multiple pressure PID selection - see 8.8	Input - on/off signal
10	D_IN1	Multiple pressure PID selection - see 8.8	Input - on/off signal
BC and BP execution			
9	VL+	Power supply 24 Vdc for driver's logic - see 8.9	Input - power supply
10	VLO	Power supply 0 Vdc for driver's logic - see 8.9	Gnd - power supply

Note: A minimum time of 270 to 590 ms have be considered between the driver energizing with the 24 Vdc power supply and when the pump is ready to operate; during this time the current to the valve coils is switched to zero.

These connections are the same of Moog radial piston pumps, model RKP-D.

6 ELECTRONIC CONNECTIONS - 4 PIN REMOTE PRESSURE TRANSDUCER M8 CONNECTOR (only for /S option)

PIN	/S option	/CS option (Ri = 316 Ω)
1	TR remote pressure trasducer feedback input (0 ÷ +10 Vdc)	TR remote pressure trasducer feedback (4 ÷ 20 mA)
2	AGND signal zero for remote transducer power supply and feedback	NC reserved (do not connect)
3	VT remote transducer power supply +24 Vdc	VT remote transducer power supply +24 Vdc
4	NC reserved (do not connect)	NC reserved (do not connect)

See tab. G465 for the pressure transducer characteristics and connections.

7 ELECTRONIC CONNECTIONS - 5 PIN COMMUNICATION M12 CONNECTOR

PIN	-PS Serial		-BC CANopen		-BP PROFIBUS DP	
	SIGNAL	TECHNICAL SPECIFICATION	SIGNAL	TECHNICAL SPECIFICATION	SIGNAL	TECHNICAL SPECIFICATION
1	NC	do not connect	CAN_SHLD	Shield	+5V	for termination
2	NC	do not connect	NC	do not connect	LINE-A	Bus line (high)
3	RS_GND	Signal zero data line	CAN_GND	Signal zero data line	DGND	data line and termination Signal zero
4	RS_RX	Valves receiving data line	CAN_H	Bus line (high)	LINE-B	Bus line (low)
5	RS_TX	Valves transmitting data line	CAN_L	Bus line (low)	SHIELD	

8 SIGNALS SPECIFICATIONS

Atos proportional pumps are CE marked according to the applicable directives (e.g. Immunity/Emission EMC Directive). Installation, wirings and start-up procedures must be performed according to the general prescriptions shown in table F003 and in the user manuals included in the E-SW programming software. The electrical signals of the pump (e.g. monitor signals) must not be directly used to activate safety functions, like to switch-ON/OFF the machine's safety components, as prescribed by the European standards (Safety requirements of fluid technology systems and components-hydraulics, EN-982)

8.1 Power supply and wirings (V+ and V0)

The power supply must be appropriately stabilized or rectified and filtered: apply at least a 10000 µF/40 V capacitance to single phase rectifiers or a 4700 µF/40 V capacitance to three phase rectifiers. A safety fuse is required in series to each driver power supply: 2,5 A fuse

8.2 Reference Input Signals (Q_INPUT+ and P_INPUT+)

The driver controls in closed loop both the pump flow and pressure proportionally to the external reference input signals. The driver is designed to receive two analog reference input signals both referred to the common mode signal zero (AGND). The inputs range and polarity are software selectable within the ±10 Vdc maximum range; default settings are 0 ÷ 10 Vdc. Drivers with fieldbus interface (-BC or -BP) can be software set to receive reference values directly by the machine control unit (fieldbus master); in this case the analog reference input signals can be used for start-up and maintenance operations.

Option /I

The maximum range of reference input signal is software selectable among 4 ÷ 20mA (default with cable break detection), ±10mA, ±20mA or 0 ÷ 20mA

8.3 Monitor Output Signal (Q_MONITOR+ and P_MONITOR+)

The driver generates an analog output signals to monitor the actual pump swashplate position and the actual pressure on the pump outlet line; the monitor output signals can be software set to show other signals available in the driver (e.g. analog reference, fieldbus reference, pilot spool position). The output range and polarity are software selectable within ±10 Vdc maximum range; default settings are 0 ÷ 10 Vdc .

Option /I

The maximum range of monitor output signal is 4 ÷ 20 mA

8.4 Fault Output Signal (FAULT)

Fault output signal indicates fault conditions of the driver (solenoid short circuits/not connected, reference signal cable broken for 4 ÷ 20mA input, pressure/swashplate/pilot transducer cable broken, etc.). Fault presence corresponds to 0 Vdc, normal working corresponds to 24 Vdc (pin 11 referred to pin2). Fault status is not affected by the status of the Enable input signal

8.5 Pressure Transducer Input Signal (TR)

A remote pressure transducer must be connected to the driver; refer to the pump's technical table to select the transducer's maximum pressure. Transducer signal range is software selectable within the ±10 Vdc maximum range; default setting is 0 ÷ +10 Vdc.

Standard

Remote pressure transducer can be directly connected to the main connector of the driver.

Option /S

Remote pressure transducer can be directly connected to a dedicated M8 connector (see section 6).

Options /C and /CS

Remote pressure transducer with current input signal can be used instead of standard 0 ÷ 10 Vdc.

Transducer signal range is software selectable among 4 ÷ 20 mA (default with cable break detection) or 0 ÷ 20 mA.

Options /X and /SX

Integral-to-pump transducer is directly connected with a dedicated cable gland and no remote transducer is required; current input signal (4 ÷ 20 mA) of the integral transducer allows cable break detection functionality.

8.6 Enable Input Signal (ENABLE) - only for /S and /SX options

To enable the driver, supply a 24 Vdc on pin 3 referred to pin 2: Enable input signal allows to enable/disable the current supply to the solenoid, without removing the electrical power supply to the driver; it is used to active the communication and the other driver functions when the pump must be disabled for safety reasons. This condition does not comply with European Norms EN13849-1 (ex EN954-1).

8.7 Logic Input Signal (D_IN) - only for standard and standard with /X option

D_IN on-off input signal can be software set to perform one of the following functions:

- enable and disable the driver functioning (apply 0 Vdc to disable and 24 Vdc to enable the driver) - see 8.6
- switch between two pressure PID settings (apply 0 Vdc to select SET1 pressure PID and 24 Vdc to select SET2) - see 10.6
- enable and disable the power limitation function (default setting, apply 0V to disable and 24Vdc to enable the power limitation) - see 10.7

8.8 Multiple pressure PID selection (D_IN0 and D_IN1) - only for /S and /SX options in PS execution

Two on-off input signals are available on the main connector to select one of the four pressure PID parameters setting, stored into the driver (see 10.6).

Switching the active setting of pressure PID during the machine cycle allows to optimize the system dynamic response in different hydraulic working conditions.

Supply a 24V or a 0V on pin 9 and/or 10, to select one of the PID settings as indicated in the table at side.

PID SET SELECTION				
PIN	SET 1	SET 2	SET 3	SET 4
9	0	0	24 Vdc	24 Vdc
10	0	24 Vdc	24 Vdc	0

8.9 Logic power supply (VL+ and VL0) - only for /S and /SX options in BC or BP execution

Separate power supply for the solenoid and for the digital electronic circuits (pin 9,10).

Cutting solenoid power supply (pin 1,2) allows to interrupt the valve functioning but keeping energized the digital electronics thus avoiding fault conditions of the machine fieldbus controller.

This condition allows to realize safety systems in compliance with European Norms EN13849-1 (ex EN954-1).

Note: pin 2 and 10 (zero Volt) are connected together inside the electronics; see 8.1 for power supplies requirements

8.10 Possible combined options: /CS, /SX, /CI, /IS, /IX, /CIS and /ISX.

9 SOFTWARE TOOLS

The driver configuration and parameters can be easily set with the Atos E-SW programming software, available in three different versions according to the driver's communication interfacing: **E-SW-PS/S** (Serial), **E-SW-BC/S** (CANopen) and **E-SW-BP/S** (PROFIBUS DP).

A proper connection is required between the PC and the electronic driver communication port: for a more detailed description of software interface, PC requirements, adapters, cables and terminators, please refer to technical table **G500**.

Proportional pumps with fieldbus communication interface (-BC and -BP) can be directly managed by the machine control unit; it is required to implement in the machine control the Atos communication protocol as described in the user manuals supplied with the relevant programming software.

Programming software, must be ordered separately :

E-SW-*/S (mandatory - first supply) = Dvd including E-SW-*/S software installer and operator manuals; it allows the registration to Atos digital service
E-SW-*-N/S (optional - next supplies) = as above but not allowing the registration to Atos digital service

On first supply of the E-SW-*/S software, it is required to apply for the registration in the Atos download area : www.download.atos.com .
 Once the registration is completed, the password will be sent by email.

The software remains active for 10 days from the installation date and then it stops until the user inputs his password.

With the password you can also download, in your personal area, the latest releases of the Atos software, manuals, drivers and configuration files.

USB Adapters, Cables and Terminators can be ordered separately (see tab. G500)

10 MAIN SOFTWARE PARAMETER SETTINGS

For a detailed descriptions of available settings, wirings and installation procedures, please refer to the programming manual E-MAN-RI-PQ included in the E-SW-*/S Dvd programming software (see section 9)

10.1 Scale

Scale function allows to set the maximum pump flow and pressure at maximum reference signal value. This regulation allows to reduce the maximum pump regulations in front of maximum reference signal. Two different Scale regulations are available for flow and pressure.

10.2 Bias

The Bias function can be set to limit internally the minimum flow and pressure references independently from the external reference value thus optimizing pumps's performances. Refer to the programming manuals for a detailed description of other software selectable Bias functions

10.3 Ramps

The ramp generator allows to convert sudden change of electronic reference signal into smooth time-dependent increasing/decreasing of both pump regulations.

Different ramp mode can be set (separately for flow and pressure):

- single ramp for any reference variation
- two ramps for increasing and for decreasing reference variations

Ramp generator is useful for application where smooth hydraulic actuation is necessary to avoid machine vibration and shocks.

If the pump is driven by a closed loop controller, the ramps can lead to unstable behaviour, for these applications ramp function can be software disabled (default setting)

10.4 Linearization

Linearization function allows to set the relation between the reference input signal and the controlled pump's regulation (separately for flow and pressure).

Linearization is useful for applications where it is required to linearize the pump's regulation in a defined working condition

10.5 Dither

The dither is an high frequency modulation added to the pump's reference signal (flow and pressure) to reduce the hysteresis of the pump's regulations; in fact a small vibration in the pump's hydraulic regulation considerably reduces the mechanical friction effects (e.g. due to cylinder seals).

Dither frequency and amplitude are software selectable; the amplitude is automatically reduced at high reference values (high regulated flow) to avoid possible instability.

Lower frequency and higher amplitude reduce hysteresis but also reduce the regulation stability. In some application this can lead to vibration and noise: right setting usually depends on system setup. Dither default setting is disabled

10.6 Multiple pressure PID

Four sets for pressure PID parameters are stored into the driver: switching in real-time the active pressure PID parameters during machine cycle allows to optimize the system dynamic response in different hydraulic working conditions (volume, flow, etc.).

The available commands to switch these PID pressure sets depend on the driver execution:

Driver	Commands
Standard and Standard with /X option	1 on-off input on main connector allow to switch the 2 PID parameters (SET1 and SET2, see 8.7)
/S and /SX options in PS execution	2 on-off inputs allow to switch the 4 PID parameters set (SET1.. SET4 - see 8.8)
BC and BP executions	real-time fieldbus communication can switch between the 4 PID parameters set (SET1.. SET4 - see driver manuals)

10.7 Hydraulic Power Limitation

A limit to the maximum pump's hydraulic power can be software set into the driver thus limiting the electric power consumption of the motor coupled to the pump: when the actual requested hydraulic power $p \times Q$ (pressure transducer feedback x flow reference value) reaches the max power limit ($p1 \times Q1$), the driver automatically reduces the flow pump regulation.

The higher is the pressure feedback the lower is the pumps's regulated flow:

$$\text{Flow regulation} = \text{Min} \left(\frac{\text{PowerLimit [sw setting]}}{\text{Transducer Pressure Feedback}} ; \text{Flow Reference} \right)$$

The hydraulic power limitation, disabled as default, can be enabled using the Atos pc software or the fieldbus communication (-BC and -BP executions).

Standard and standard with /X option allow also to enable and disable this function during the machine cycle, using the D_IN on-off input available on the main connector (see 8.7)

10.1, 10.2 - Scale, Bias

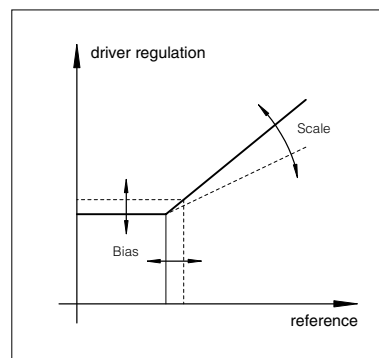

10.3 - Ramps

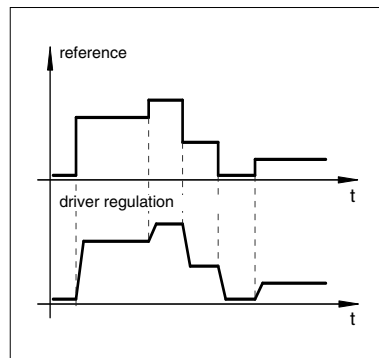

10.4 - Linearization

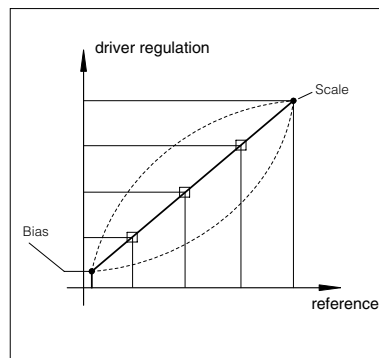

10.7 - Hydraulic Power Limitation

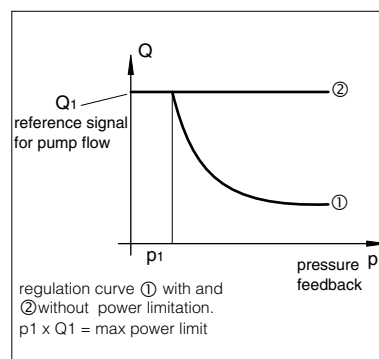

11 DRIVER CHARACTERISTICS

Power supply (see 8.1, 8.8)	Nominal: +24 Vdc Rectified and filtered: $V_{rms} = 20 \pm 32 V_{MAX}$ (ripple max 10 % V_{PP})		
Max power consumption	50 W		
Reference input signal (see 8.2)	Voltage: range $\pm 10 V_{dc}$	Input impedance: $R_i > 50 k\Omega$	
Pressure feedback signal (see 8.5)	Current: range $4 \pm 20 mA$	Input impedance: $R_i = 316 \Omega$	
Monitor output (see 8.3)	Output range : voltage $\pm 10 V_{dc}$ @ max 5mA current $4 \pm 20 mA$ @ max 500 Ω load resistance		
on-off input (see 8.6/8.7/8.9)	Range : $0 \pm 5 V_{dc}$ (OFF state), $9 \pm 24 V_{dc}$ (ON state), $5 \pm 9 V_{dc}$ (not accepted); Input impedance: $R_i > 10 k\Omega$		
Fault output (see 8.4)	Output range : $0 \pm 24 V_{dc}$ (ON state $>$ [power supply] - 2 V ; OFF state $<$ 1V) @ max 50mA		
Alarms	Solenoid not connected/short circuit, overtemperature, under temperature, cable break for: pilot valve spool feedback, swashplate feedback, current reference, and current pressure trasducer feedback		
Format	Sealed box on the valve; IP67 protection degree		
Operating temperature	$-20 \pm 60 ^\circ C$ (storage $-20 \pm 70 ^\circ C$)		
Mass	approx. 475g		
Additional characteristics	Short circuit protection of solenoid's current supply; alternate swashplate and pressure control by P.I.D.		
Electromagnetic compatibility (EMC)	According to Directive 2004/108/CE (Immunity: EN 50082-2; Emission: EN 50081-2)		
Communication interface Physical Layer Protocol	-PS Serial	-BC CANopen - see tab. G510	-BP PROFIBUS - see tab. G510
	serial RS232 Atos ASCII coding	optical insulated CAN ISO11898 CANopen EN50325-4 + DS408	optical insulated RS485 PROFIBUS DP EN50170-2/IEC61158
Recommended wiring cable	LiYCY shielded cables: 0,5 mm ² for length up to 40m [1,5 mm ² for power supply and solenoid]		

12 MAIN CONNECTOR CHARACTERISTICS (to be ordered separately)

CODE	SP-ZH-12P
Type	Female straight circular socket plug 12pin
Standard	DIN 43651
Material	Plastic reinforced with fiber glass
Cable gland	PG16
Cable	LiCY 10 x 0,14 mm ² (signal) - LiYY 3 x 1 mm ² (power supply)
Connection type	to crimp
Protection (DIN 40050)	IP 65

13 REMOTE PRESSURE TRANSDUCER CONNECTOR CHARACTERISTICS (to be ordered separately)

CODE	SP-ZH-4P-M8/5
Type	Male straight circular socket plug 4 pin
Standard	M8 – IEC 60947-5-2
Material	Plastic
Cable gland	Connector moulded on cable 5 m lenght
Cable	4x 0,25 mm ²
Connection type	cable
Protection (DIN 40050)	IP 67

14 COMMUNICATION CONNECTOR CHARACTERISTICS (to be ordered separately)

CODE	-PS Serial Connector	-BC CANopen Connector	-BP PROFIBUS DP Connector
	SP-ZH-5P	SP-ZH-5P	SP-ZH-5P/BP
Type	Female straight circular socket plug 5 pin	Female straight circular socket plug 5 pin	Male straight circular socket plug 5 pin
Standard	M12 – IEC 60947-5-2	M12 – IEC 60947-5-2	M12 – IEC 60947-5-2
Material	Plastic	Plastic	Plastic
Cable gland	PG9	PG9	PG9
Cable	LiYCY 5x0,25 mm ² shielded	CANBus Standard (301 DSP)	PROFIBUS DP Standard
Connection type	screw terminal	screw terminal	screw terminal
Protection (DIN 40050)	IP 67	IP 67	IP 67

15 OVERALL DIMENSIONS [mm]

