

Stainless steel ex-proof solenoid directional valves

on-off, direct, poppet type leak free - **ATEX, IECEX, EAC, PESO, CCC** or **cULus**

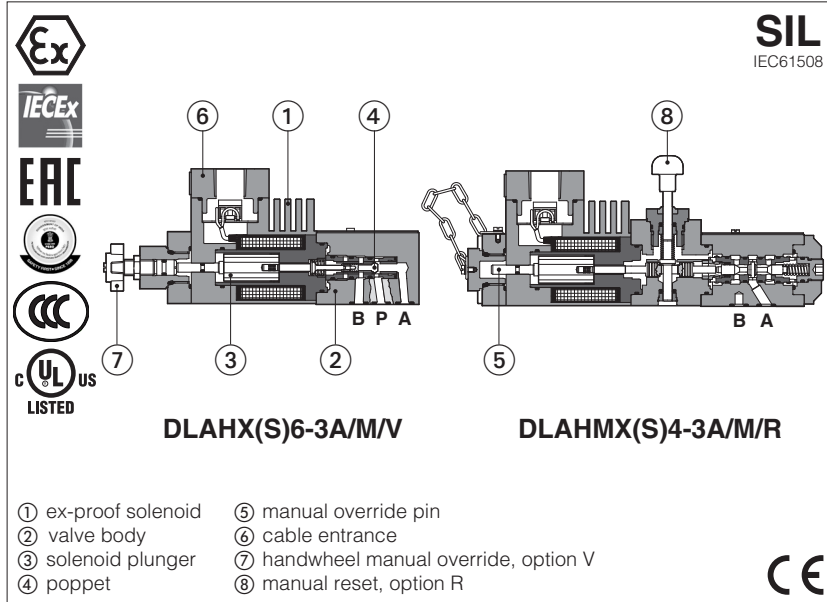

DLAHX, DLAHXS, DLAHM(S), DLAHMX(S)

Ex-proof, poppet type, directional solenoid valves made in two different stainless steel executions for corrosive environments and fluids.

- X** full stainless steel for external and internal parts, to withstand extreme and corrosive environmental conditions, and to ensure full compatibility also with water base and special fluids.
- XS** stainless steel only for external parts to withstand extreme and corrosive environmental conditions.

Ex-proof stainless steel solenoids are provided with **ATEX, IECEX, EAC, PESO, CCC Multicertification** or **cULus** North American certification, see sect. 8.

DLAHX and DLAHXS are **SIL** compliance with IEC 61508 (TÜV certified)

DLAHX(S):
Size: **06** - ISO 4401
3/2 way
Max flow: **12 l/min**
Max pressure: **350 bar**

DLAHMX(S):
Size: **06** - ISO 4401
3/2 way
Max flow: **30 l/min**
Max pressure: **315 bar**

1 MODEL CODE

DLAH	X	6	*	-	3	A	/	M	/	V	24DC	*	/	*	/	*
Ex-proof solenoid directional valve, leak free DLAH = max flow 12 l/min DLAHM = max flow 30 l/min												Series number				Test fluid, only for X execution (3): H = mineral oil W = pure water
Stainless steel executions (1): X = full stainless steel XS = stainless steel only external parts																Seals material, see section 6: - = NBR low temp. -40°C PE = FKM BBT = FVMQ fluorosilicon -60°C (4)
Solenoid power and Temperature class , see also certification data in section 8 (2): Multicertification 4 = 25W, class T4/T3 6 = 8W, class T6/T4 cULus 4 = 33W, class T3 6 = 12W, class T6/T5																Voltage code - see section 5
Certification type: - = omit for Multicertification (Group II) UL = cULus certification																Options - see section 13 for possible combined options: O = horizontal cable entrance R = solenoid manual reset (not combinable with V) V = handwheel manual override (not combinable with R)
3 = three way																Solenoid threaded connection for cable gland fitting: M = M20x1,5 for Multicertification NPT = 1/2" NPT for /UL
																Valve configuration - see section 2: A = A to T in rest position C = P to A in rest position - P to B for DLAHX(S)

(1) See section 6 for materials specification.

(2) 6 and 4 versions differ only for the coil power, see power consumption at section 5 and operating limits at section 15.

(3) The "X" valves in full stainless steel execution are factory tested by Atos with mineral oil or pure water in order to avoid the contamination of the end user system. At the end of each valve model code must be specified the type of fluid to be used in the valve's testing: "H" for hydraulic oil or "W" for pure water.

(4) Only for Multicertified valves in full stainless steel "X" execution (not available for valves with UL certification)

1.1 Summary of available models

Valve execution		Multicertification		cULus		Max flow (l/min)	Max pressure (bar)
X	XS	Tclass	Power	Tclass	Power		
DLAHX4	DLAHXS4	T4, T3	25W	T3	33W	12	350
DLAHX6	DLAHXS6	T6, T4	8W	T6, T5	12W	10	315, 350
DLAHMX4	DLAHMXS4	T4, T3	25W	T3	33W	25, 30	315
-	DLAHMXS6	T6, T4	8W	T6, T5	12W	25	250

2 CONFIGURATIONS AND HYDRAULIC SYMBOLS (representation according to ISO 1219-1)

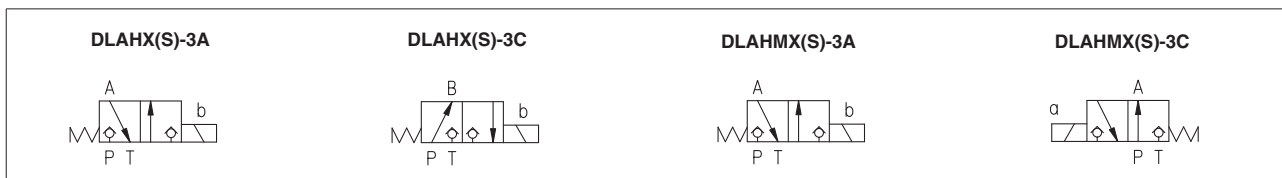

3 GENERAL CHARACTERISTICS

Assembly position / location	Any position
Subplate surface finishing	Roughness index Ra 0,4 - flatness ratio 0,01/100 (ISO 1101)
MTTFd values according to EN ISO 13849	150 years, for further details see technical table P007
Ambient temperature	Standard = -40°C ÷ +70°C /PE option = -20°C ÷ +70°C /BBT option = -60°C ÷ +70°C
Storage temperature range	Standard = -40°C ÷ +80°C /PE option = -20°C ÷ +80°C /BBT option = -60°C ÷ +80°C
Compliance	Explosion proof protection, see section 8 -Flame proof enclosure "Ex d" -Dust ignition protection by enclosure "Ex t" SIL to IEC 61508: 2010, see section 9 (only for DLAHX and DLAHXS) RoHs Directive 2011/65/EU as last update by 2015/863/EU REACH Regulation (EC) n°1907/2006

4 HYDRAULIC CHARACTERISTICS

Valve type	DLAHX4 DLAHXS4	DLAHX6	DLAHXS6	DLAHMX4	DLAHMXS4	DLAHMXS6
Valve size	06	06	06	06	06	06
Max operating pressure: ports P, A, B [bar]	350	315	350	315	315	250
port T [bar]	120					
Rated flow	see diagrams Q/Δp at section 14					
Max flow (1) [l/min]	12	10	10	25	30	25
Internal leakage [cm³/min]	less than 5 drops/min (0,36 cm³/min) at max pressure					

(1) see diagram at section [15](#)

The pressure at T port makes difficult the manual override operation that can be possible only if its value is lower than 50 bar

5 ELECTRICAL CHARACTERISTICS

Valve type	DLAHX4 DLAHXS4 DLAHMX4 DLAHMXS4	DLAHX6 DLAHXS6 DLAHMX6 DLAHMXS6	DLAHX4/UL DLAHXS4/UL DLAHMX4/UL DLAHMXS4/UL	DLAHX6/UL DLAHXS6/UL DLAHMX6/UL DLAHMXS6/UL
Voltage code (1) VDC ±10%	12DC, 24DC, 48DC, 110DC, 125DC, 220DC		12DC, 24DC, 110DC, 125DC, 220DC	
VAC 50/60 Hz ±10%	12AC, 24AC, 110AC, 230AC		12AC, 24AC, 110AC, 230AC	
Power consumption at 20°C	25W	8W	33W	12W
Coil insulation	class H			
Protection degree with relevant cable gland	IP66/67 to DIN EN60529		raintight enclosure, UL approved	
Duty factor	100%			

(1) For alternating current supply a rectifier bridge is provided built-in the solenoid.

For power supply frequency 60 Hz, the nominal supply voltage of solenoids 110AC and 230AC must be 115/60 and 240/60 respectively

6 MATERIALS SPECIFICATION

Valve code	Solenoid housing	Valve body	Internal parts	Spring	Seals		
					std	/PE	/BBT
DLAHX	AISI 630	AISI 316L	AISI 316L, 420B, 440C, 430F	AISI 302	NBR 70 Sh low temp	FKM (viton)	FVMQ (fluorosilicon)
DLAHXS	AISI 630	AISI 316L	Carbon steel	AISI 302	NBR 70 Sh low temp	FKM (viton)	-
DLAHMX	AISI 630	AISI 316L	AISI 316L, 420B, 440C, 430F	AISI 302	NBR 70 Sh low temp	FKM (viton)	FVMQ (fluorosilicon)
DLAHMXS	AISI 630	AISI 316L	Carbon steel	AISI 302	NBR 70 Sh low temp	FKM (viton)	-

7 SEALS AND HYDRAULIC FLUIDS - for other fluids not included in below table, consult our technical office

Seals, recommended fluid temperature (1)	NBR seals (standard) = -40°C ÷ +60°C FKM seals (/PE option) = -20°C ÷ +80°C FVMQ seals (/BBT option) = -60°C ÷ +60°C		
Recommended viscosity	15÷100 mm ² /s - max allowed range 2.8 ÷ 500 mm ² /s		
Max fluid contamination level	15÷100 mm ² /s - max allowed range 2.8 ÷ 500 mm ² /s min = 0,9 mm ² /s for X full stainless steel execution with pure water		
Hydraulic fluid	Suitable seals type	Classification	Ref. Standard
Mineral oils	NBR low temp., FKM, FVMQ	HL, HLP, HLPD, HVLP, HVLPD	DIN 51524
Flame resistant without water	FKM, FVMQ	HF DU, HF DR	ISO 12922
Flame resistant with water (2)	NBR low temp.	HFA-E, HFA-S, HFB, HFC	

(1) The operating temperature of the fluid must be compatible with the maximum viscosity range allowed for the valve

(2) Performance limitations in case of flame resistant fluids with water:

-max operating pressure = 210 bar -max fluid temperature = 50°C

 The ignition temperature of the hydraulic fluid must be 50°C higher than the max solenoid surface temperature

8 CERTIFICATION DATA

8.1 Certification data for ambient temperature range -40 ÷ +70°C

Valve type	DLAHX4, DLAHXS4 DLAHMX4, DLAHMXS4	DLAHX6, DLAHXS6 - , DLAHMXS6	DLAHX4/UL, DLAHXS4/UL DLAHMX4/UL, DLAHMXS4/UL	DLAHX6/UL, DLAHXS6/UL - , DLAHMXS6/UL
Certifications	Multicertification ATEX IECEX EAC PESO CCC		North American cULus	
Solenoid certified code	OAKX/WP OAKXS/WP	OAX/WP OAXS/WP	OAKX/EC/WP OAKXS/EC/WP	OAX/EC/WP OAXS/EC/WP
Temperature class	T4	T3	T6	T4
Surface temperature	135°C	200°C	85°C	135°C
Ambient temperature	-40 ÷ +45°C	-40 ÷ +70°C	-40 ÷ +45°C	-40 ÷ +70°C
			-40 ÷ +70°C	-40 ÷ +55°C -40 ÷ +70°C

8.2 Certification data for ambient temperature range -60 ÷ +70°C (valves with option /BBT)

Valve type	DLAHX4 /BBT DLAHMX4 /BBT	DLAHX6 /BBT
Certifications	Multicertification ATEX IECEX EAC PESO CCC	
Solenoid certified code	OABKX/WP	OABX/WP
Temperature class	T4	T3
Surface temperature	135°C	200°C
Ambient temperature	-60 ÷ +45°C	-60 ÷ +70°C
		-60 ÷ +45°C -60 ÷ +70°C

8.3 Certificates and applicable standards

Certifications	Multicertification Group II ATEX IECEX EAC PESO CCC	North American cULus
Type examination certificate (1)	ATEX: CESI 02 ATEX 014 IECEX: IECEX CES 10.0010x EAC: RU C - IT.AЖ38.B.00425/21 PESO: P523614/1 CCC: 2024322307005903	20170324 - E366100
Method of protection	<ul style="list-style-type: none"> • ATEX Ex II 2G Ex db IIC T6/T4/T3 Gb Ex II 2D Ex tb IIIC T85°C/T200°C Db • IECEX, CCC Ex db IIC T6/T4/T3 Gb Ex tb IIIC T85°C/T200°C Db • EAC 1Ex d IIC T6/T4/T3 Gb X Ex tb IIIC T85°C/T200°C Db X • PESO Exd IIC T6/T4/T3 Gb 	<ul style="list-style-type: none"> • UL 1203 Class I, Div.I, Groups C & D Class I, Zone I, Groups IIA & IIB
Applicable standards	EN 60079-0 EN 60079-1 EN 60079-31	IEC 60079-0 IEC 60079-1 IEC 60079-31
Cable entrance:	M20x1,5	UL 1203 and UL429, CSA 22.2 n°30-1986 CSA 22.2 n°139-13
		1/2" NPT ANSI/ASME B46.1

(1) The type examiner certificates can be downloaded from www.atos.com

 **WARNING: service work performed on the valve by the end users or not qualified personnel invalidates the certification**

9 SIL compliance with IEC 61508: 2010 - only DLAHX and DLAHXS

DLAHX and DLAHXS meet the requirements of:

- **SC3** (systematic capability)
- max **SIL 2** (HFT = 0 if the hydraulic system does not provide the redundancy for the specific safety function where the component is applied)
- max **SIL 3** (HFT = 1 if the hydraulic system provides the redundancy for the specific safety function where the component is applied)

10 EX PROOF SOLENOIDS WIRING

Multicertification

Standard version **Option /O**

① cover with threaded connection for vertical cable gland fitting
 ② cover with threaded connection for horizontal cable gland fitting
 ③ terminal board for cables wiring
 ④ standard manual override protected by cap
 ⑤ screw terminal for additional equipotential grounding

	1 = Coil PCB 3 poles terminal board 2 = GND suitable for wires cross sections 3 = Coil up to 2,5 mm ² (max AWG14)
--	--

cULus certification

Standard version **Option /O**

① cover with threaded connection for vertical cable gland fitting
 ② cover with threaded connection for horizontal cable gland fitting
 ③ terminal board for cables wiring
 ④ standard manual override protected by cap

Pay attention to respect the polarity

	1 = Coil + PCB 3 poles terminal board sugges- 2 = GND ted cable section up to 1,5 mm ² 3 = Coil - (max AWG16), see section 11 note 1
--	---

alternative GND screw terminal
 connected to solenoid housing

11 CABLE SPECIFICATION AND TEMPERATURE - Power supply and grounding cables have to comply with following characteristics:

<p>Multicertification</p> <p>Power supply: section of coil connection wires = 2,5 mm² max</p>	<p>Grounding: section of internal ground wire = 2,5 mm² max section of external ground wire = 4 mm² min</p>
<p>cULus certification:</p> <ul style="list-style-type: none"> • Suitable for use in Class I Division 1, Gas Groups C • Armored Marine Shipboard Cable which meets UL 1309 • Tinned Stranded Copper Conductors • Bronze braided armor • Overall impervious sheath over the armor <p>Any Listed (UBVZ/ UBVZ7) Marine Shipboard Cable rated 300 V min, 15A min. 3C 2,5 mm² (14 AWG) having a suitable service temperature range of at least -40°C to +110°C</p> <p>Note 1: For Class I wiring the 3C 1,5 mm² AWG 16 cable size is admitted only if a fuse lower than 10 A is connected to the load side of the solenoid wiring.</p>	

11.1 Cable temperature

The cable must be suitable for the working temperature as specified in the "safety instructions" delivered with the first supply of the products.

Multicertification

Solenoid code	Max ambient temperature [°C]	Temperature class	Max surface temperature [°C]	Min cable temperature
OA(B)X	45°C	T6	85°C	not prescribed
OA(B)XS	70°C	T4	135°C	90°C
OA(B)KX OA(B)KXS	45°C	T4	85°C	100°C
	50°C	T3	200°C	100°C
	60°C	T3	200°C	120°C
	70°C	T3	200°C	130°C

cULus certification

Solenoid code	Max ambient temperature [°C]	Temperature class	Max surface temperature [°C]	Min cable temperature
OAX/EC	55°C	T6	85°C	100°C
OAXS/EC	70°C	T5	100°C	100°C
OAKX/EC	55°C	T3	200°C	115°C
OAKXS/EC	70°C	T3	200°C	140°C

12 CABLE GLANDS - only Multicertification

Cable glands with threaded connections M20x1,5 for standard or armoured cables have to be ordered separately, see tech. table **KX800**

Note: a Loctite sealant type 545, should be used on the cable gland entry threads

13 OPTIONS

O = horizontal cable entrance, to be selected in case of limited vertical space

R = the R device operates as a security (not combinable with /V).

When the valve is electrically energized, the manual reset knob must be manually lifted at the same time in order to permit the poppet to move from the rest position to the switched position. The return of the valve to the rest position does not require lifting the manual reset knob.

V = with handweel manual override (not combinable with /R)

Option /R

Lift to permit the valve switching

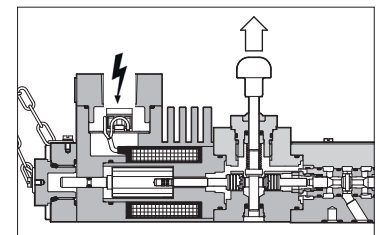

13.1 Possible combined options

OR, OV

14 Q/Δp DIAGRAMS (based on mineral oil ISO VG 46 at 50°C)

Valve type	Curve	Flow direction
DLAHX(S)-3A	C	P-A, P-B
	B	A-T, B-T
DLAHX(S)-3C	B	P-A, P-B
	A	A-T, B-T

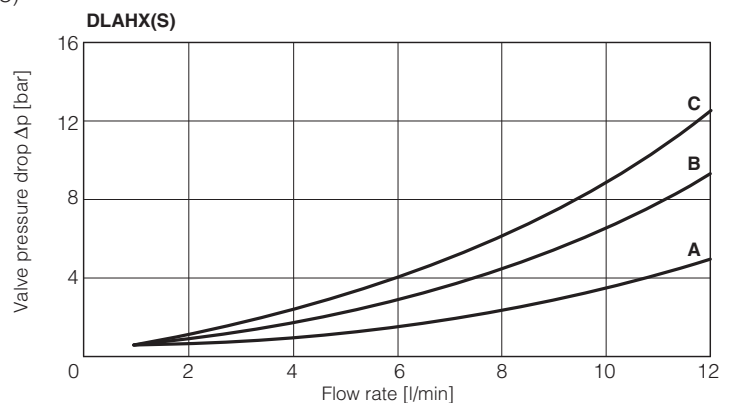

Valve type	Curve	Flow direction
DLAHMX(S)-3A	E	P-A, P-B
	D	A-T, B-T
DLAHMX(S)-3C	E	P-A, P-B
	D	A-T, B-T

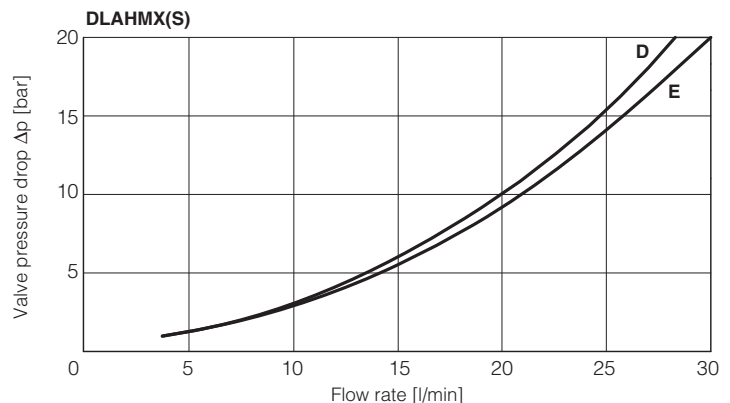

15 OPERATING LIMITS (based on mineral oil ISO VG 46 at 50°C)

The diagram have been obtained with warm solenoids and power supply at lowest value ($V_{nom} - 10$).

Valve type	Curve	Configuration
DLAHX4	A	3C
	B	3A

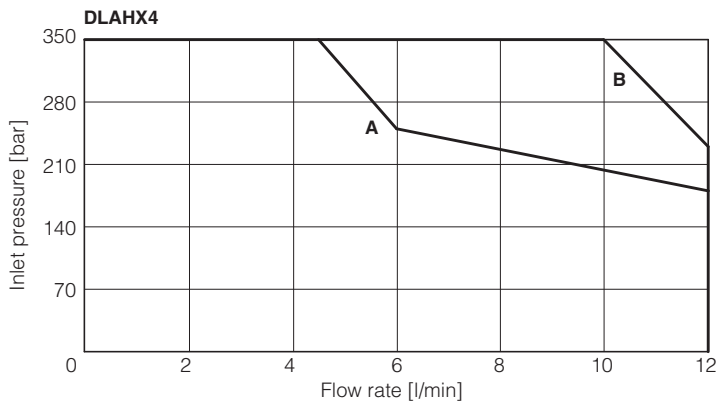

Valve type	Curve	Configuration
DLAHXS4	C	3A , 3C

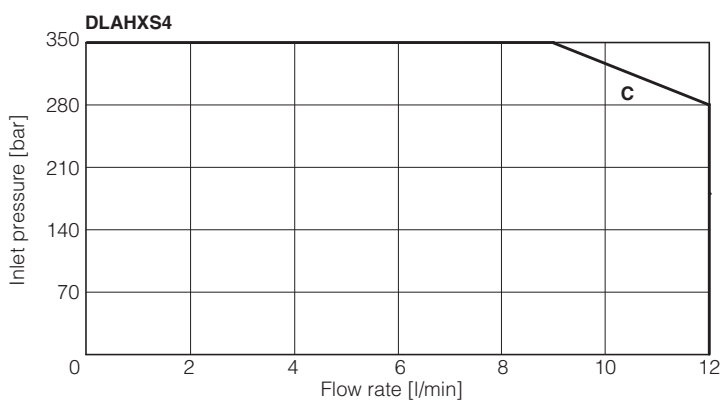

Valve type	Curve	Configuration
DLAHX6	D	3A
	E	3C

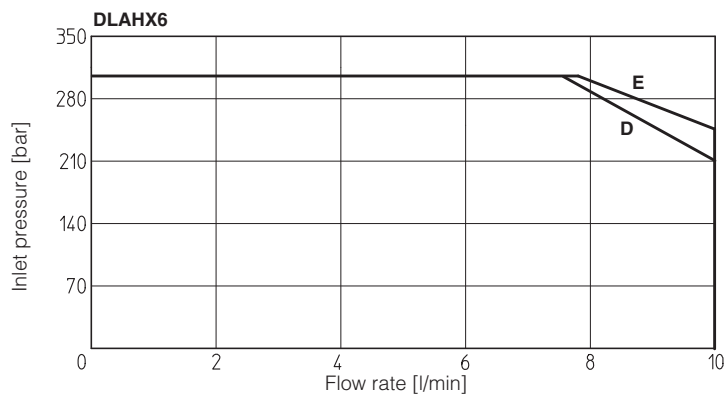

Valve type	Curve	Configuration
DLAHXS6	F	3A
	G	3C

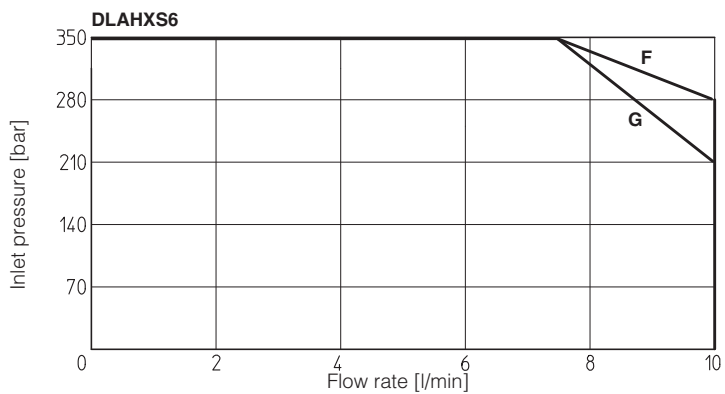

Valve type	Curve	Configuration
DLAHMX4	H	3C
	I	3A

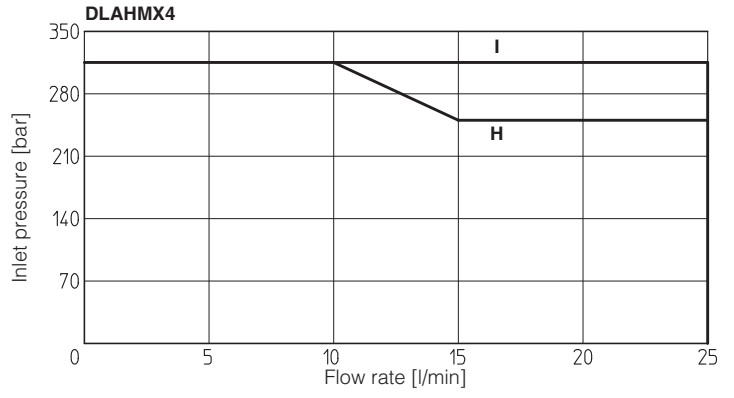

Valve type	Curve	Configuration
DLAHMXS4	L	3A
	M	3C

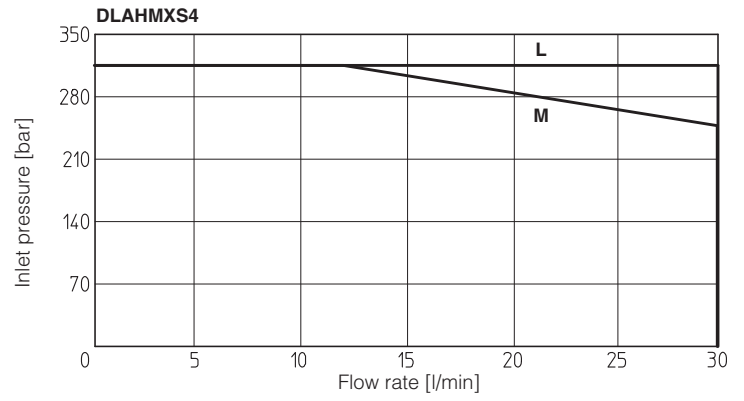

Valve type	Curve	Configuration
DLAHMXS6	N	3A , 3C

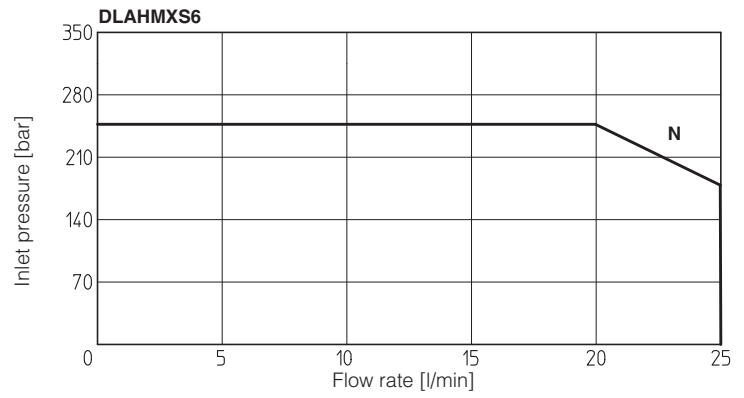

16 FASTENING BOLTS AND SEALS

	<p>Fastening bolts: 4 socket head screws M5x50-A4-70 Tightening torque = 5,5 Nm</p>		<p>Seals: 4 OR 108; Diameter of ports P, A, B, T: Ø 7,5 mm (max)</p>
--	--	--	---

17 INSTALLATION DIMENSIONS [mm]

ISO 4401: 2005
Mounting surface: 4401-03-02-0-05

Mass [kg]	
DLAHX(S)*-3A/M/V	3
DLAHX(S)*-3C/M	2,9
DLAHMX(S)*-3A/M/R	3,8
DLAHMX(S)*-3C/M	2,9
Option /O	+0,35

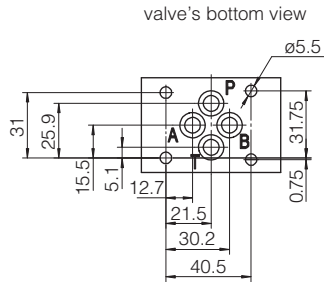

horizontal cable entrance option /O

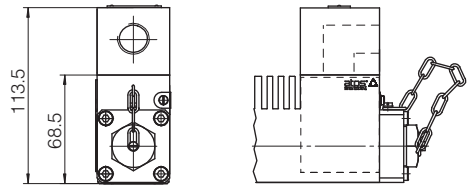

- P** = PRESSURE PORT
- A** = USE PORT (not used for -3C version)
- B** = USE PORT (not used for -3A version)
- T** = TANK PORT

DLAHX(S)*-3A/M/V

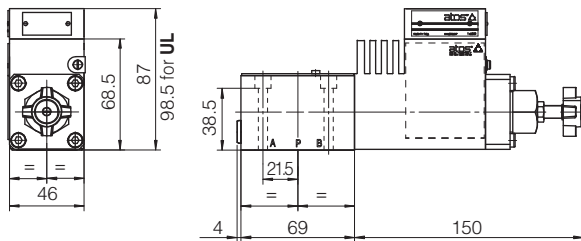

DLAHX(S)*-3C/M

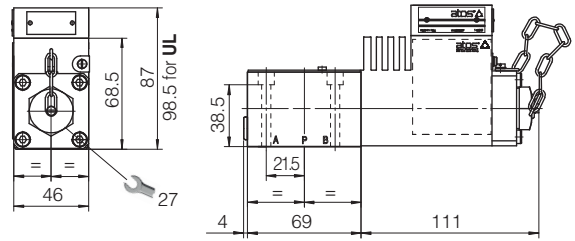

DLAHMX(S)*-3A/M/R

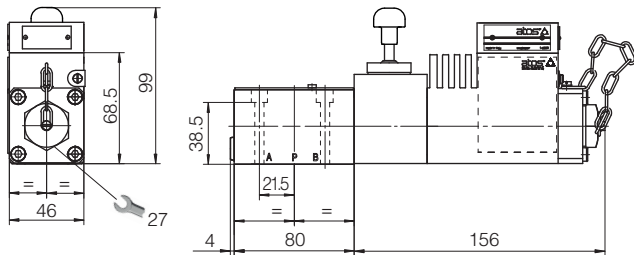

DLAHMX(S)*-3C/M

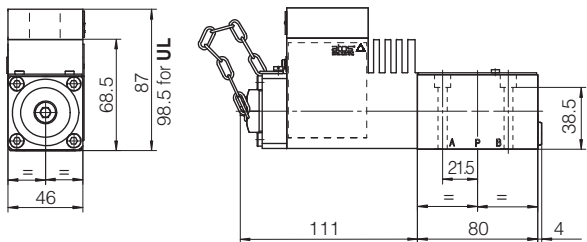

18 RELATED DOCUMENTATION

W010	Basics for electrohydraulics in corrosive environments	X010	Basics for electrohydraulics in hazardous environments
W020	Summary of Atos stainless steel components	KX800	Cable glands for ex-proof valves
EW900	Operating and maintenance information for stainless steel on-off valves	P005	Mounting surfaces for electrohydraulic valves